

# BREADCRUMB 280











Your Grain Mill Grinder



**KARAKI**  
BAKERY EQUIPMENT

# BREADCRUMB 280

## POWERFUL GRAIN PROCESSOR

-  The BREADCRUMB 280 is meant to grind nuts, corn, wheat and much more.
-  Designed in-house and made entirely from food grade stainless steel.
-  Thanks to the robust hinge on the side that allows for easy inside cleaning.
-  The grinding process undergoes 3 stages: knife cutting, disk slicing and hammers pounding.
-  Different screen perforations are available.
-  Two choices of powerful motors are available: 4 & 5.5 kw
-  Hourly production is more than 3 metric tons for bread crumbs.
-  Bread crumbs are widely used in food additives, mainly added to the surface such as: steak, fried chicken, fried sea food, pasta, dumplings, breaded vegetables, desserts and much more.
-  In bakeries it contributes in reducing manufacturing costs since waste is eliminated.
-  Weight of the machine: 76 kgs

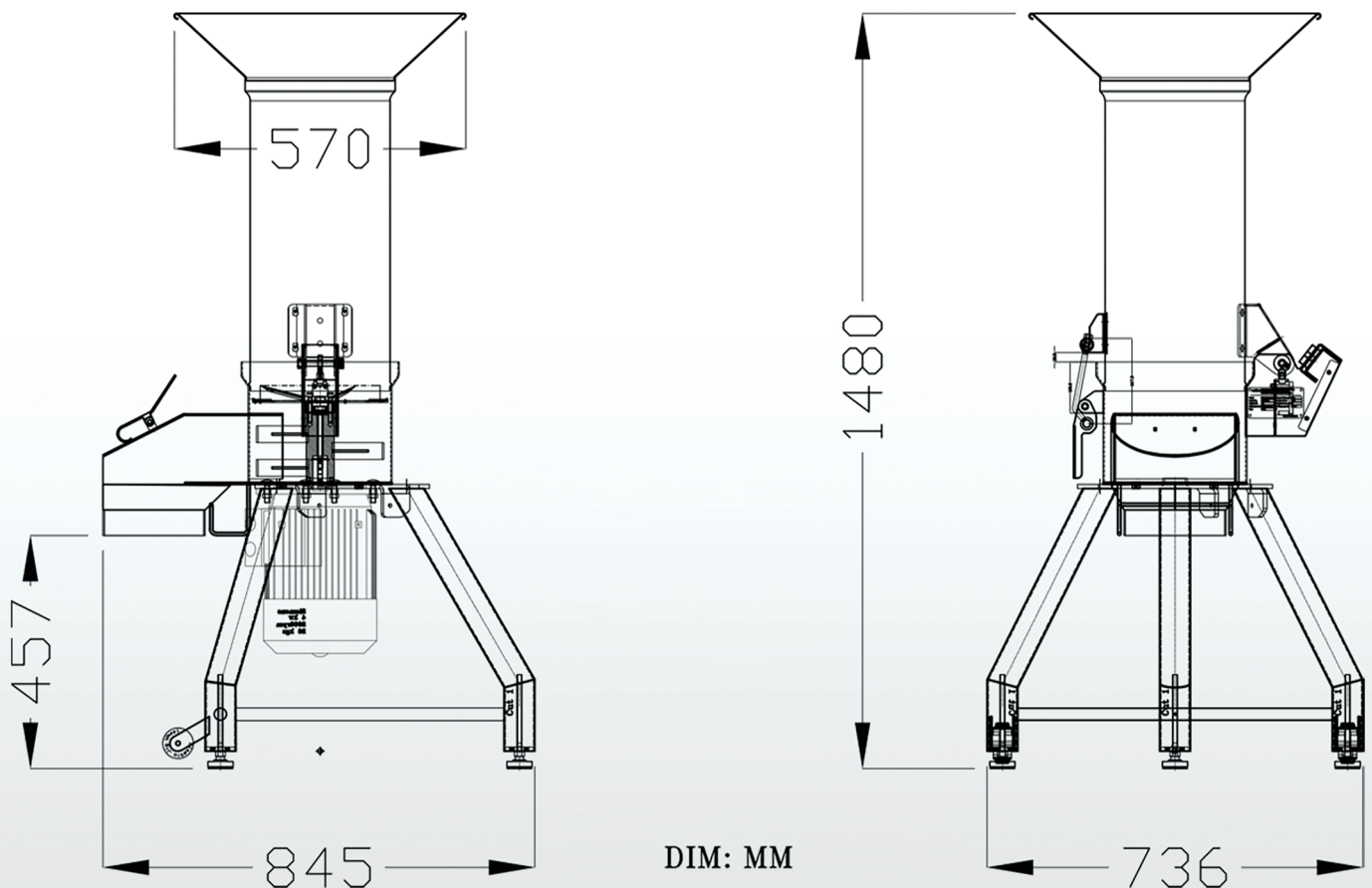

*Specifications and dimensions contained in this catalogue are based on our current knowledge and experience. Karaki Co. reserves the right to change without prior notice.*

## KARAKI FOR INDUSTRY AND TRADING SARL

KARAKI COMPOUND, ISSAM ABDEL BAKI ROAD, ZIP CODE 1500, INDUSTRIAL AREA  
AMROUSIEH-CHOWEIFAT, LEBANON

(T) +961 (0)5 434 905 (F) +961 (0)5 537 909 [www.karaki.com.lb](http://www.karaki.com.lb)